

# KOMATSU®

# WA270-8

*Tier 4 Final Engine*

## WHEEL LOADER

# WA270



Photos may include optional equipment.

### NET HORSEPOWER

149 HP @ 2000 rpm  
111 kW @ 2000 rpm

### OPERATING WEIGHT

28,208 – 29,079 lb  
12795 – 13190 kg

### BUCKET CAPACITY

2.5 – 3.5 yd<sup>3</sup>  
1.9 – 2.7 m<sup>3</sup>

# WALK-AROUND



WA270-8

Photos may include optional equipment.

## NET HORSEPOWER

149 HP @ 2000 rpm  
111 kW @ 2000 rpm

## OPERATING WEIGHT

28,208 – 29,079 lb  
12795 – 13190 kg

## BUCKET CAPACITY

2.5 – 3.5 yd<sup>3</sup>  
1.9 – 2.7 m<sup>3</sup>



## HIGH PRODUCTION WITH LOW FUEL CONSUMPTION

### Proven, Fourth Generation Hydrostatic Transmission:

- Quick Acceleration
- Dynamic Braking
- Variable Speed Traction Control
- Creeping Mode

**Komatsu SmartLoader Logic** helps reduce fuel consumption with no decrease in production.

A powerful **Komatsu SAA6D107E-3 engine** provides a net output of 111 kW **149 HP** with up to 3% improved fuel consumption. This engine is EPA Tier 4 Final emissions certified.

**Variable Geometry Turbocharger (VGT)** is hydraulically actuated to provide optimum air flow under all speed and load conditions. This Tier 4 Final version has improved performance.

**Komatsu Diesel Particulate Filter (KDPF) and Selective Catalytic Reduction (SCR) systems** reduce particulate matter and NOx while providing automatic regeneration that does not interfere with daily operation.

### Ample cooling capacity

- Auto-reversing fan is standard
- Wider core coolers

### Fluid neutral or better

Combined fuel and DEF consumption is equal to or less than the WA270-7 fuel consumption.

**Spacious cab** provides the operator with improved comfort and visibility.

### New high resolution monitor panel:

- Enhanced and intuitive on-board diagnostics
- Integrated with KOMTRAX Level 5
- Integrated with Komatsu Tier 4 Final technology

**Rearview monitoring system is standard.**

**New high capacity air suspension seat with heat is standard.**



### Energy saving guidance:

- Six operator guiding messages
- Enhanced ecology gauge

**Komatsu auto idle shutdown** helps reduce idle time and operating costs.

**Remote boom positioner** can set kickout.

**Versatile Parallel Z-bar (PZ) linkage** for parallel lift.

**Variable displacement piston pumps with Closed-Center Load Sensing System (CLSS)** help reduce fuel consumption.

The **KOMTRAX®** telematics system is standard on Komatsu equipment with no subscription fees throughout the life of the machine. Using wireless technology, **KOMTRAX®** transmits valuable information such as location, utilization, and maintenance records to a PC or smartphone app. Custom machine reports are provided for identifying machine efficiency and operating trends. **KOMTRAX®** also provides advanced machine troubleshooting capabilities by continuously monitoring machine health.

**Operator identification system** tracks machine operation for up to 100 operators.

# PERFORMANCE FEATURES

## KOMATSU NEW ENGINE TECHNOLOGIES

### New Tier 4 Final Engine

The Komatsu SAA6D107E-3 engine is EPA Tier 4 Final emissions certified, reduces fuel consumption, and provides exceptional performance. Based on Komatsu proprietary technologies developed over many years, this new diesel engine reduces nitrogen oxides (NOx) by more than 80% compared to Tier 4 interim levels.

### Technologies Applied to New Engine Heavy-Duty After Treatment System

This new system combines a Komatsu Diesel Particulate Filter (KDPF) and Selective Catalytic Reduction (SCR). The SCR NOx reduction system injects the precise amount of Diesel Exhaust Fluid (DEF) to break down NOx into non-toxic water vapor (H<sub>2</sub>O) and nitrogen gas (N<sub>2</sub>).

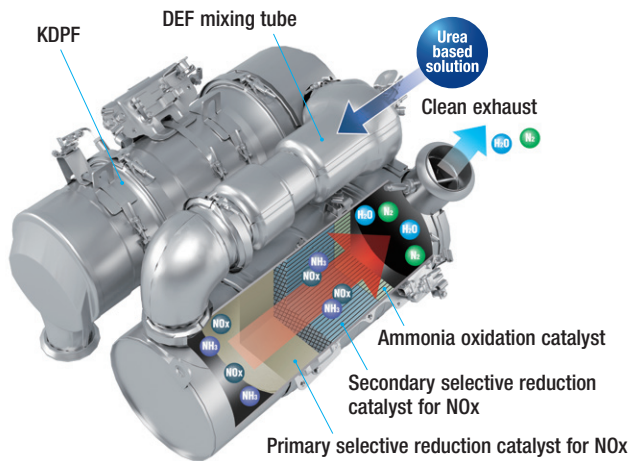

### Heavy-Duty Cooled Exhaust Gas Recirculation (EGR) System

The system recirculates a portion of exhaust gas into the air intake and lowers combustion temperatures, thereby reducing NOx emissions. EGR gas flow is lower for Tier 4 Final with the addition of SCR technology. The system dramatically reduces NOx, while helping cut fuel consumption below Tier 4 Interim levels.

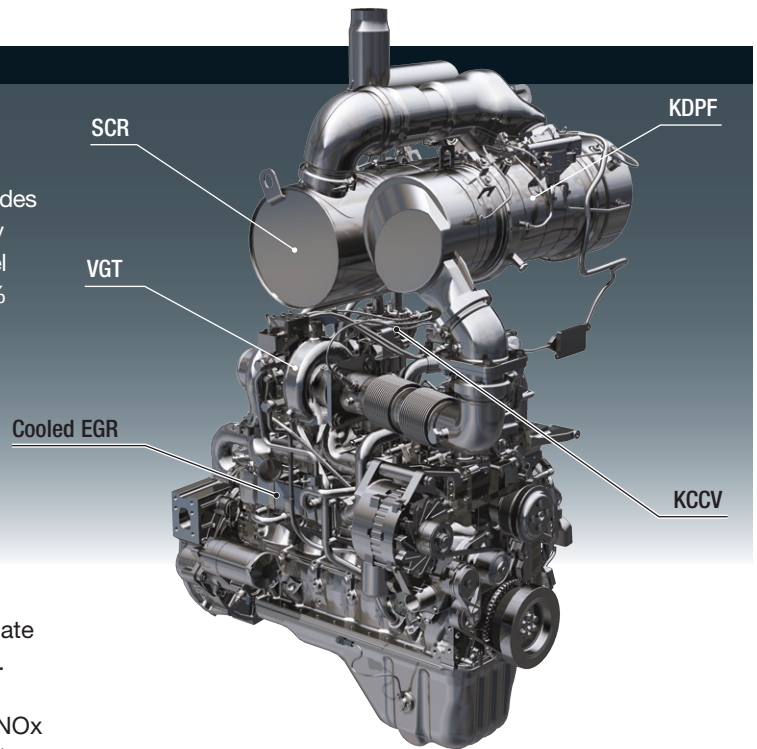
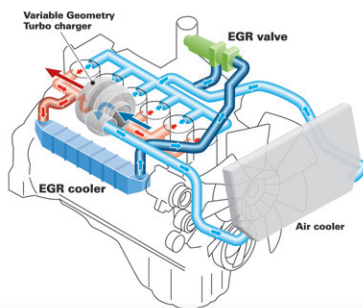

### Advanced Electronic Control System

An improved electronic control system more effectively manages engine parameters such as airflow rate, EGR gas flow rate, fuel injection parameters, and after treatment function. The control system also provides enhanced diagnostics through the monitor panel. Additionally, managing information via KOMTRAX helps customers track required maintenance.

### Variable Geometry Turbocharger (VGT) system

The VGT features proven Komatsu-designed hydraulic technology for robust and accurate control under all speed and load conditions for optimal engine performance. The VGT also provides precise exhaust temperature control for efficient KDPF regeneration. The Tier 4 Final version has a smaller impeller for improved performance.

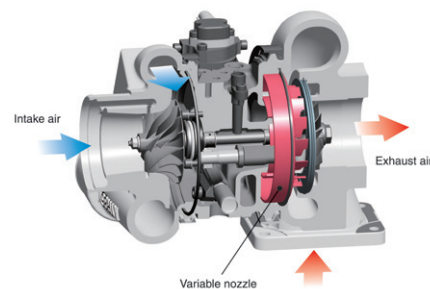

WA270-8

### Heavy-Duty High-Pressure Common Rail (HPCR) fuel injection system

The system is specifically designed to achieve the optimal injection of fuel for near-complete combustion, which helps reduce Particulate Matter (PM) emissions.

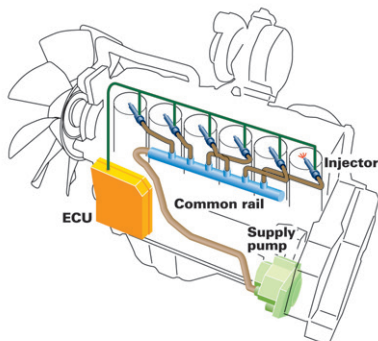

### Komatsu SmartLoader Logic

The WA270-8 features Komatsu SmartLoader Logic, which controls engine torque to match machine demands. For example, engine torque needs are higher for digging in V-shape loading, but lower when driving with an empty bucket. This system optimizes the engine torque for all applications to minimize fuel consumption. Komatsu SmartLoader Logic functions automatically and doesn't interfere with operation, saving fuel without decreasing production.

### Hydrostatic Transmission (HST)

The HST provides quick travel response and aggressive drive into the pile. Full auto-shifting eliminates any gear shifting and kick-down operation to allow the operator to concentrate on the digging and loading. The HST also acts as a dynamic brake to slow the loader. This dramatically extends the life of the wet disc brakes.

### Variable Traction Control System

The variable traction control system is designed to adjust the traction control for each working condition. S-mode reduces tire spin in slippery or snowy conditions. Auto-mode automatically optimizes the tractive effort for various working conditions. Max traction provides the full, 100%, tractive effort.

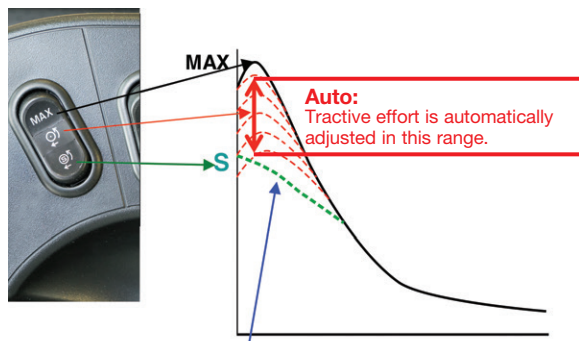

**S-mode:**  
Improve tire slip ratio on snowy or slippery road condition

### Creep Mode

Creep mode limits the travel speed in 1st speed range, while still allowing for full hydraulic flow.



### Closed-Center Load Sensing System (CLSS)

The one-pump, two-motor system utilizes a Closed-Center Load Sensing System (CLSS) pump. This system minimizes hydraulic loss for better fuel economy by delivering only as much flow as the job requires.

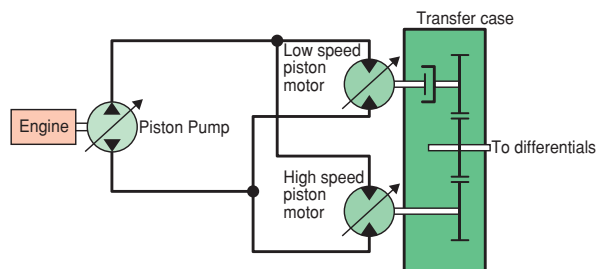

### Komatsu Auto Idle Shutdown

In order to reduce unwanted idle time, Komatsu offers Komatsu auto idle shutdown. This function will shut the engine off and apply the parking brake and hydraulic lock after a preset idle time limit. This time limit can be set by the operator or service technician and may range from three to 60 minutes. It can also be deactivated by the operator.



# OPERATOR ENVIRONMENT



## New Operator Seat

A new standard, heated, air-suspension seat provides enhanced support on rough roads and dampens machine vibrations, providing a more comfortable ride for the operator. The angle of the armrest is fully adjustable for optimum operator comfort. A secondary F-N-R switch is incorporated into the standard multi-function mono lever.



## Tiltable / Telescopic Steering Wheel

The operator can tilt and telescope the steering wheel to allow maximum comfort and control. The two-spoke steering wheel allows maximum visibility of the monitor panel and the forward work environment.



## Low Noise Design

Operator's ear noise level: 68 dB(A)  
Dynamic noise level (outside): 104 dB(A)

The large ROPS/FOPS cab is mounted with Komatsu's unique viscous mounts. The low-noise engine, hydraulically-driven fan, and hydraulic pumps are mounted with rubber cushions, and the cab sealing is improved to provide a quiet, low-vibration, comfortable operating environment.

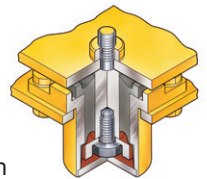

## Increased Cab Storage Area

The WA270-8 cab features a storage box on each side of the cab to allow the operator to store items such as a beverage or lunch.





**Standard Rear View Monitoring System**

The dedicated, full-color monitor on the right side of the cab provides the operator with a rear view from the machine. This monitor can be always on or only on when the loader shifts into reverse. Guidelines provide the operator with visual cues for the width of the loader.



**Engine Shutdown Secondary Switch**

The engine stop switch enables machine shutdown when accessing the key switch is not possible.

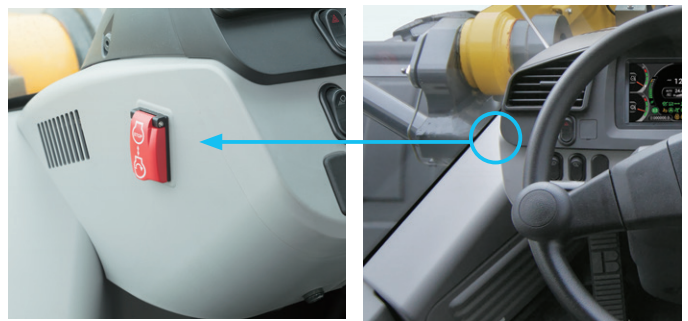

**Auxiliary Input (MP3 Jack) 12 V Outlets**

An Aux input for audio devices is standard as well as two 12 volt outlets. These are all located on the rear wall of the cab.

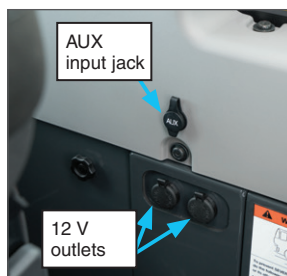

# WORKING ENVIRONMENT



## Easy Entry and Exit

The WA270-8 has an inclined ladder with wide steps and well-placed hand holds to ease entry and exit from the cab. The door latch can be reached from ground level to ease opening and closing the door.

## Electronically Controlled Suspension System

The standard Electronically Controlled Suspension System or ride control system uses an accumulator, which absorbs some of the shock in the boom arm, giving the operator a much smoother ride. This reduces operator fatigue and reduces material spillage during load and carry operations. Ride control is speed sensitive and the activation speed can be adjusted in the monitor panel.

## Multi-Function Mono Lever

The multi-function mono lever with EPC control for 3rd spool is standard. It includes a forward-neutral-reverse switch for quick and easy travel. Third spool attachments can be set to continual or proportional control via the monitor panel. This allows the operator to control the boom, bucket and attachment, all with a single lever.



## Remote Boom Positioner

The operator can set the upper boom limit from the cab.

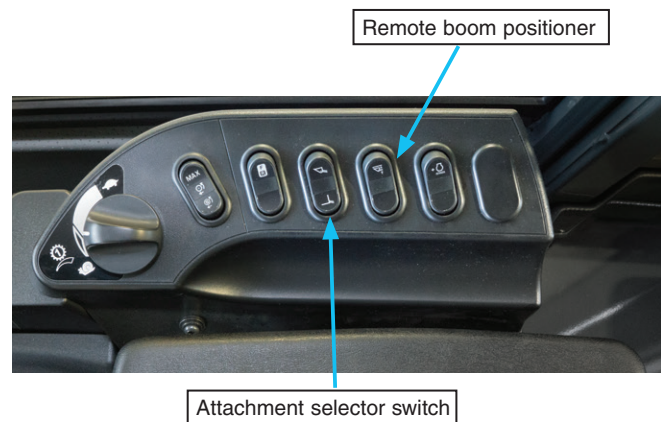

## Attachment Selector Switch

Coupler equipped machines, which use buckets and forks, require a different flat level setting when switching between attachments. The attachment selector switch found in coupler equipped machines tells the loader which flat level to use.



# INFORMATION & COMMUNICATION TECHNOLOGY

## New High Resolution LCD Monitor Panel

The new seven inch color LCD monitor panel displays operational information, ecology guidance and maintenance records. Information such as traction mode, coolant temp, oil and fuel levels are easy to read and help keep the operator informed of the machine's settings and conditions.

### Machine monitor

- 1 LCD unit
- 2 LED unit
- 3 Engine tachometer
- 4 Speedometer
- 5 Ecology gauge
- 6 Air conditioner display
- 7 Traction level
- 8 Engine coolant temperature gauge
- 9 Fuel gauge
- 10 HST oil temperature gauge
- 11 Variable speed display
- 12 Message pilot lamp
- 13 Pilot lamps
- 14 DEF level gauge

### Switch panel

- 1 Air conditioner switches / Numeral key pad
- 2 Function switches

## Visual user menu

Pressing the menu button on the switch panel accesses the user-menu screen. The menus are grouped by function, with easy-to-understand, intuitive icons for easier machine operation.

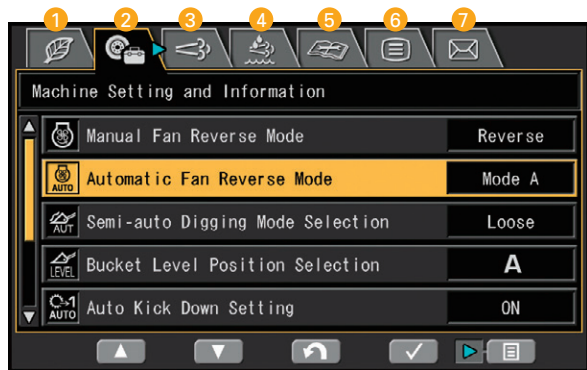
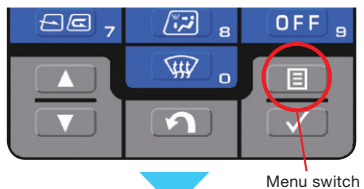

- 1 Energy saving guidance
- 2 Machine settings
- 3 Aftertreatment devices regeneration
- 4 SCR information
- 5 Maintenance
- 6 Monitor setting
- 7 Mail check



## Operator identification function

An operator identification (ID) code can be set for each operator, and used to manage operation information of individual machines through KOMTRAX. Data sent from KOMTRAX can be used to analyze operation status by operator job, as well as by machine.



## Monitor Panel with troubleshooting function minimizes downtime

Various meters, gauges and warning functions are centrally arranged on the monitor panel. The monitor simplifies start-up inspection and warns the operator with a lamp and buzzer if any abnormalities occur. Warnings are indicated in four levels, which the operator must acknowledge and clear.

Replacement times for oil and filters are also indicated.



# MAINTENANCE FEATURES



WA270-8

## Side-opening Gull-wing Engine Doors

The large, gull-wing-type engine doors require minimal effort to open and close, thanks to gas assisted struts. The doors make access and daily maintenance easy. Large steps on each side of the frame also enhance accessibility.



## Auto Reversing Fan

The engine cooling fan is hydraulically driven. It can be set to reverse automatically during operation. Fan reverse mode and timing can be controlled through the monitor.

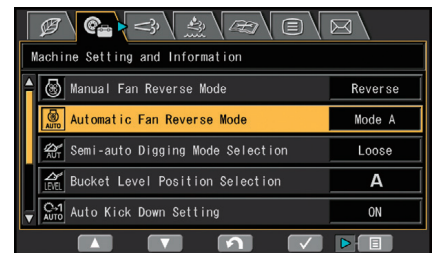

## Swing-Out Type Cooling Fan and Wide Core Radiator

The cooling fan swings out for easier cleaning. The coolers feature wide-spaced cooling fins to reduce clogging.



## DEF Tank

The DEF tank is easily accessed behind the RH side ladder. An external sight gauge helps prevent overflow and spillage while refilling.



## Battery Disconnect Switch

The battery disconnect switch is located on the right side of the machine. This can be used to disconnect power when performing service work on the machine.



## Engine Compartment

The WA270-8 engine compartment is designed for easy serviceability. Placement of maintenance items, such as filters, dipsticks, and oil-fill locations are laid out for easy-to-reach, ground-level access.

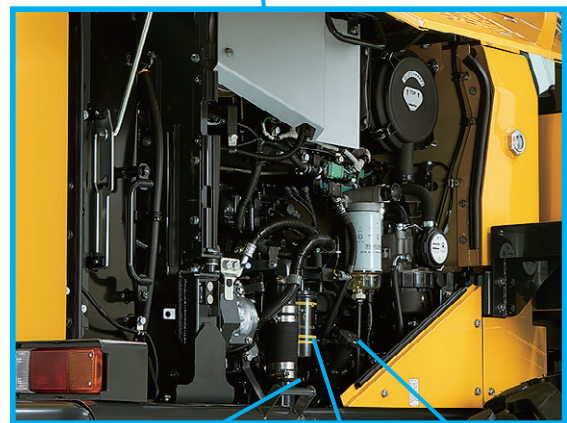
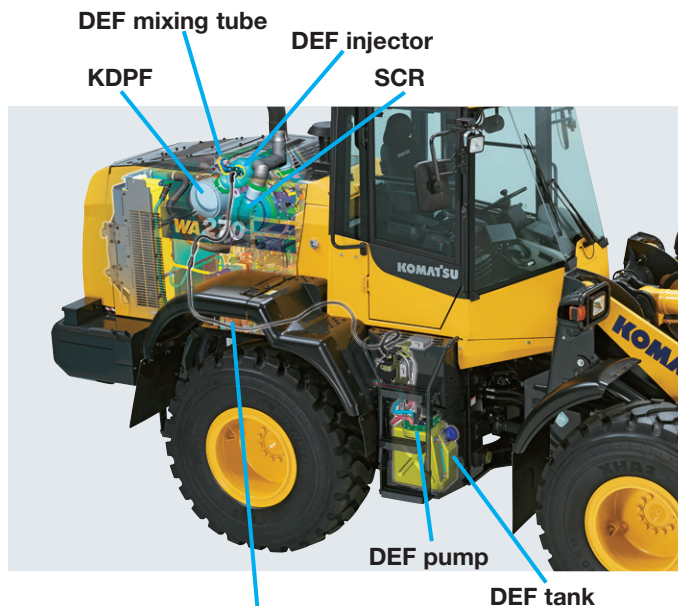

## Rear Full Fenders (Option)

The WA270-8 has a new rear fender option. The rear fenders open upward and use gas-assist struts, which require low lift force.

The fenders swing up with the gull-wing doors to give the technician easy access to the engine compartment. Mud flaps are also included on the rear fenders.



## Cab Air Filter

The inside and outside air filters can be replaced easily without the need for tools. The outside filter is located behind a lockable door for security.

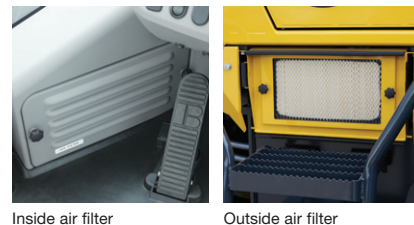

## Maintenance Information

### “Maintenance time caution lamp” display

When the time before required maintenance dips below 30 hours\*, the maintenance-time monitor appears. Pressing the menu switch displays the maintenance screen.

\* : The setting can be changed within the range between 10 and 200 hours.

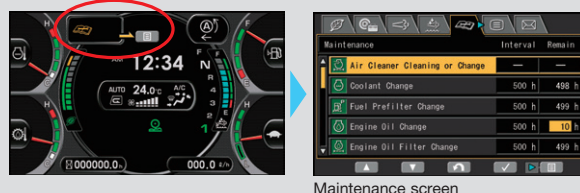

### Supports DEF level and refill timing

The DEF level gauge is displayed continuously on the monitor panel. In addition, when the refill timing is reached, the DEF-low-level icon appears to alert the operator.

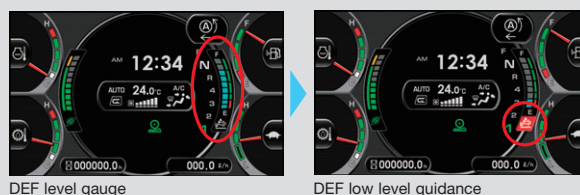

# KOMATSU PARTS & SERVICE SUPPORT



## KOMATSU CARE

### Program Includes:

\*The WA270-8 comes standard with complimentary factory scheduled maintenance for the first 3 Years or 2,000 Hours, whichever comes first.

### Planned Maintenance Intervals at:

500/1000/1500/2000 hour intervals. (250 hr. initial interval for some products) Complimentary Maintenance Interval includes: Replacement of Oils & Fluid Filters with genuine Komatsu Parts, 50-Point inspection, Komatsu Oil & Wear Analysis Sampling (KOWA) / Travel & Mileage (distance set by distributor; additional charges may apply)

### Benefits of Using Komatsu CARE

- Assurance of Proper Maintenance with OEM Parts & Service
- Increased Uptime & Efficiency
- Factory Certified Technicians Performing Work
- Cost of Ownership Savings
- Transferable Upon Resale

### Complimentary KDPF Exchanges

The WA270-8 comes standard with 2 Complimentary KDPF Exchange units for the first 5 Years or 9000 hours whichever comes first. The suggested KDPF Exchange unit service intervals are 4500 hours & 9000 hours during the first 5 Years. End user must have authorized Komatsu distributor perform the removal & installation of the KDPF.

### Complimentary SCR Maintenance

The WA270-8 also includes 2 factory recommended services of the Selective Catalytic Reduction (SCR) Diesel Exhaust Fluid (DEF) system during the first 5 Years or 9000 hours whichever comes first. The service includes factory recommended DEF tank flush & strainer cleaning at the suggested service intervals of 4500 hours & 9000 hours.

Interval PM	i250	500	1000	1500	2000
CLEAN AC FRESH AND RECIRC AIR FILTERS	✓				
REPLACE HYDRAULIC OIL FILTER ELEMENT	✓				
REPLACE HST OIL FILTER	✓		✓		✓
KOWA SAMPLING – (Engine, Front Axle & Rear Axle, Hydraulics, Transfer case)	✓	✓	✓	✓	✓
CHECK AND CLEAN AIR CLEANER	✓	✓	✓	✓	✓
CHECK AND CLEAN FUEL BREATHER ELEMENT	✓	✓	✓	✓	✓
LUBRICATE REAR AXLE PIVOT PIN	✓	✓	✓	✓	✓
LUBRICATE WORK EQUIPMENT	✓	✓	✓	✓	✓
DRAIN SEDIMENT FROM FUEL TANK	✓	✓	✓	✓	✓
COMPLETE 50 POINT INSPECTION FORM; LEAVE PINK COPY WITH CUSTOMER OR IN CAB	✓	✓	✓	✓	✓
RESET MONITOR PANEL MAINTENANCE COUNTER FOR APPROPRIATE ITEMS	✓	✓	✓	✓	✓
CHANGE ENGINE OIL		✓	✓	✓	✓
REPLACE ENGINE OIL FILTER		✓	✓	✓	✓
REPLACE AC FRESH & RECIRC AIR FILTERS		✓	✓	✓	✓
REPLACE FUEL PRE-FILTER		✓	✓	✓	✓
REPLACE FUEL MAIN FILTER			✓	✓	✓
CHANGE OIL IN TRANSFER CASE			✓	✓	✓
CLEAN TRANSFER CASE STRAINER			✓	✓	✓
CLEAN TRANSFER BREATHER			✓	✓	✓
LUBRICATE CENTER HINGE PIN			✓	✓	✓
CHANGE OIL IN HYDRAULIC TANK				✓	✓
REPLACE HYDRAULIC TANK BREATHER ELEMENT					✓
REPLACE DEF TANK BREATHER					✓
REPLACE DEF PUMP FILTER					✓
CLEAN HYDRAULIC TANK STRAINER					✓
CHANGE FRONT AND REAR AXLE OIL					✓
CLEAN BRAKE CIRCUIT STRAINER					✓
REPLACE KCCV FILTER					✓
FACTORY TRAINED TECHNICIAN LABOR	✓	✓	✓	✓	✓
2 KDPF Exchanges at 4,500 Hrs and 9,000 Hrs.					
2 SCR System Maintenance Services at 4,500 Hrs. and 9000 Hrs.					

## Komatsu CARE® – Extended Coverage

- Extended Coverage can provide peace of mind by protecting customers from unplanned expenses that effect cash flow
- Purchasing extended coverage locks-in the cost of covered parts and labor for the coverage period and helps turn these into fixed costs



## Komatsu Parts Support

- 24/7/365 to fulfill your parts needs
- 9 parts Distribution Centers strategically located across the U.S. and Canada
- Distributor network of more than 300 locations across U.S. and Canada to serve you
- Online part ordering through Komatsu eParts
- Remanufactured components with same-as-new warranties at a significant cost reduction



## Komatsu Oil and Wear Analysis (KOWA)

- KOWA detects fuel dilution, coolant leaks, and measures wear metals
- Proactively maintain your equipment
- Maximize availability and performance
- Can identify potential problems before they lead to major repairs
- Reduce life cycle cost by extending component life

\* Certain exclusions and limitations apply. Refer to the customer certificate for complete program details and eligibility. Komatsu® and Komatsu Care® are registered trademarks of Komatsu Ltd. Copyright 2019 Komatsu America Corp.

WA270-8

# KOMTRAX EQUIPMENT MONITORING

GET THE WHOLE STORY WITH  
**KOMTRAX**<sup>®</sup>

✓ **WHAT**

- KOMTRAX is Komatsu's remote equipment monitoring and management system
- KOMTRAX **continuously monitors and records** machine health and operational data
- Information such as fuel consumption, utilization, and a detailed history **lowering owning and operating cost**

✓ **WHEN**

- Know when your machines are **running or idling** and make decisions that will improve your fleet utilization
- Detailed movement records ensure you know when and where your equipment is moved
- Up to date records allow you to **know when maintenance is due** and help you plan for future maintenance needs

✓ **WHERE**

- KOMTRAX data **can be accessed virtually anywhere** through your computer, the web or your smart phone
- Automatic alerts keep fleet managers up to date on the latest machine notifications

✓ **WHY**

- Knowledge is power - **make informed decisions** to manage your fleet better
- Knowing your idle time and fuel consumption will help maximize your machine efficiency
- **Take control of your equipment** - any time, anywhere

✓ **WHO**

- KOMTRAX is **standard** equipment on all Komatsu construction products



**KOMTRAX**<sup>®</sup>

For construction and compact equipment.

**KOMTRAX Plus**<sup>®</sup>

For production and mining class machines.

# SPECIFICATIONS



## ENGINE

Model..... Komatsu SAA6D107E-3\*  
 Type..... Water-cooled, 4-cycle  
 Aspiration..... Variable geometry turbo-charged, after-cooled, cooled EGR  
 Number of cylinders..... 6  
 Bore..... 107 mm **4.21"**  
 Stroke..... 124 mm **4.88"**  
 Piston displacement..... 6.69 ltr **408 in<sup>3</sup>**  
 Governor..... All-speed, electronic  
 Horsepower:  
 SAE J1995..... Gross 115 kW **153 HP**  
 ISO 9249 / SAE J1349..... Net 111 kW **149 HP**  
 Rated rpm..... 2000 rpm  
 Max power - ISO 14396..... 111 kW **149 HP @ 1650 rpm**  
 Fan drive method for radiator cooling..... Hydraulic  
 Fuel system..... Direct injection  
 Lubrication system:  
 Method..... Gear pump, force-lubrication  
 Filter..... Full-flow type  
 Air cleaner..... Dry type with double elements and dust evacuator, plus dust indicator

\*EPA Tier 4 Final emissions certified



## TRANSMISSION

Transmission..... Hydrostatic, 1 pump, 2 motors with speed range select

Travel speed	Forward	Reverse
<b>1st</b>	1.0 - 13.0 km/h <b>0.6 - 8.1 mph</b>	1.0 - 13.0 km/h <b>0.6 - 8.1 mph</b>
<b>2nd</b>	13.0 km/h <b>8.1 mph</b>	13.0 km/h <b>8.1 mph</b>
<b>3rd</b>	19 km/h <b>11.8 mph</b>	19 km/h <b>11.8 mph</b>
<b>4th</b>	38.0 km/h <b>23.6 mph</b>	38.0 km/h <b>23.6 mph</b>

Measured with 20.5-R25 tires



## AXLES AND FINAL DRIVES

Drive system..... Four-wheel drive  
 Front..... Fixed, semi-floating  
 Rear..... Center-pin support, semi-floating, 24° total oscillation  
 Reduction gear..... Spiral bevel gear  
 Differential gear..... Torque proportioning  
 Final reduction gear..... Planetary gear, single reduction



## BRAKES

Service brakes..... Hydraulically actuated, wet disc brakes actuate on four wheels  
 Parking brake..... Wet, multi-disc brake on transfer output shaft  
 Secondary brake..... Parking brake is commonly used



## STEERING SYSTEM

Type..... Articulated type, fully-hydraulic power steering  
 Steering angle..... 38° each direction (40° to max end stop)  
 Minimum turning radius at the center of outside tire..... 5175 mm **17' 0"**



## HYDRAULIC SYSTEM

Steering system:  
 Hydraulic pump..... Piston pump, in common with loader control  
 Capacity..... 150 ltr/min **39.6 U.S. gal/min** at rated rpm  
 Relief valve setting..... 20.6 MPa 210 kgf/cm<sup>2</sup> **3,000 psi**  
 Hydraulic cylinders:  
 Type..... Double-acting, piston type  
 Number of cylinders..... 2  
 Bore x stroke..... 70 mm x 453 mm **2.76" x 17.8"**  
 Loader control:  
 Hydraulic pump..... Piston pump, in common with steering system  
 Capacity..... 150 ltr/min **39.6 U.S. gal/min** at rated rpm  
 Relief valve setting..... 31.4 MPa 320 kgf/cm<sup>2</sup> **4,554 psi**  
 Hydraulic cylinders:  
 Type..... Double-acting, piston type  
 Number of cylinders—bore x stroke:  
 Lift cylinder..... 2- 110 mm x 717 mm **4.3" x 28.2"**  
 Bucket cylinder..... 1- 140 mm x 480 mm **5.5" x 18.9"**  
 Control valve..... 2-spool type  
 Control positions:  
 Boom..... Raise, hold, lower, and float  
 Bucket..... Tilt-back, hold, and dump  
 Hydraulic cycle time (rated load in bucket)  
 Raise..... 6.0 sec  
 Dump..... 2.0 sec  
 Lower (Empty)..... 3.2 sec



## SERVICE REFILL CAPACITIES

Cooling system..... 33.3 ltr **8.8 U.S. gal**  
 Fuel tank..... 186 ltr **49.1 U.S. gal**  
 Engine..... 23 ltr **6.1 U.S. gal**  
 Hydraulic system..... 80 ltr **21.1 U.S. gal**  
 Axle front..... 18.5 ltr **4.9 U.S. gal**  
 Axle rear..... 18.0 ltr **4.8 U.S. gal**  
 Transfer case..... 7 ltr **1.8 U.S. gal**  
 DEF tank..... 14 ltr **3.7 U.S. gal**



## BUCKET SELECTION GUIDE

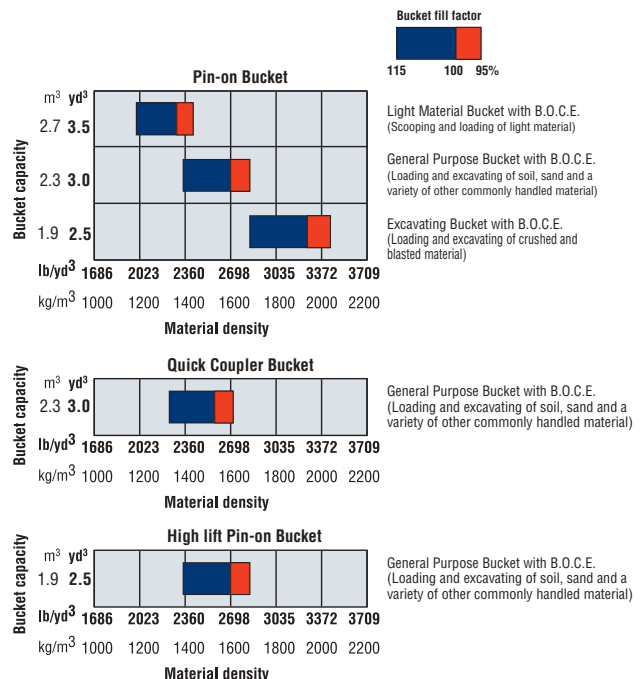



## DIMENSIONS

Measured with 20.5-R25(L3) Tires, ROPS/FOPS cab

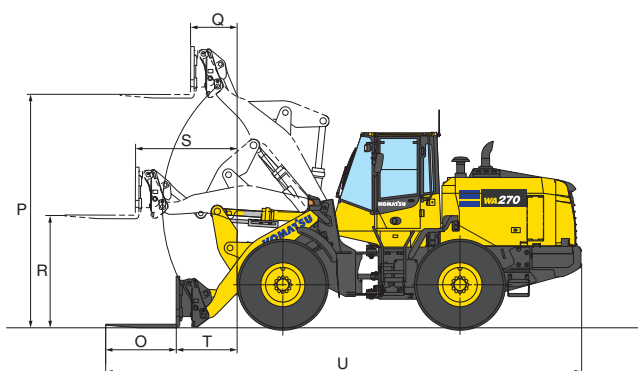
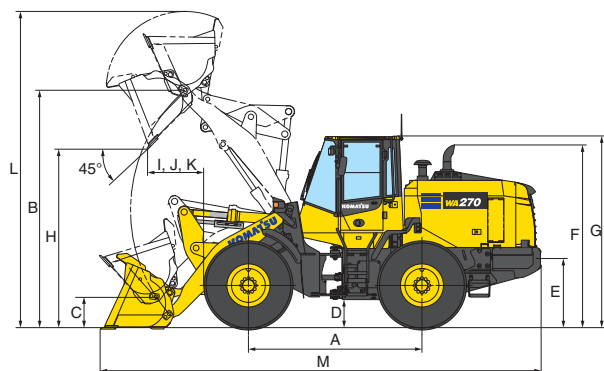

Tread		1930 mm	<b>6'4"</b>
Width over tires		2505 mm	<b>8'3"</b>
A Wheelbase		2900 mm	<b>9'6"</b>
B Hinge pin height,	Standard Boom	3965 mm	<b>13'0"</b>
max. height	High Lift Boom	4390 mm	<b>14'5"</b>

C Hinge pin height,	Standard Boom	515 mm	<b>1'8"</b>
carry position	High Lift Boom	630 mm	<b>2'1"</b>
D Ground clearance		465 mm	<b>1'6"</b>
E Hitch height		950 mm	<b>3'1"</b>
F Overall height, top of the stack		3050 mm	<b>10'0"</b>
G Overall height, ROPS cab		3200 mm	<b>10'6"</b>

## BUCKET

	High Lift				
	General Purpose Bucket w/ Pin On B.O.C.E.	Excavating Bucket w/ Pin On B.O.C.E.	Light Material Bucket w/ Pin On B.O.C.E.	General Purpose Bucket w/ Quick Coupler B.O.C.E.	Excavating Bucket w/ Pin On B.O.C.E.
Bucket capacity: heaped	2.3 m <sup>3</sup> <b>3.0 yd<sup>3</sup></b>	1.9 m <sup>3</sup> <b>2.5 yd<sup>3</sup></b>	2.7 m <sup>3</sup> <b>3.5 yd<sup>3</sup></b>	2.3 m <sup>3</sup> <b>3.0 yd<sup>3</sup></b>	1.9 m <sup>3</sup> <b>2.5 yd<sup>3</sup></b>
struck	2.1 m <sup>3</sup> <b>2.7 yd<sup>3</sup></b>	1.6 m <sup>3</sup> <b>2.1 yd<sup>3</sup></b>	2.4 m <sup>3</sup> <b>3.1 yd<sup>3</sup></b>	2.1 m <sup>3</sup> <b>2.7 yd<sup>3</sup></b>	1.6 m <sup>3</sup> <b>2.1 yd<sup>3</sup></b>
Bucket width	2550 mm <b>8'4"</b>	2550 mm <b>8'4"</b>	2550 mm <b>8'4"</b>	2685 mm <b>8'10"</b>	2550 mm <b>8'4"</b>
Bucket weight	970 kg <b>2,138 lb</b>	885 kg <b>1,951 lb</b>	1030 kg <b>2,271 lb</b>	1075 kg <b>2,370 lb</b>	771 kg <b>1,700 lb</b>
H Dumping clearance, max. height and 45° dump angle*	2975 mm <b>9'9"</b>	3055 mm <b>10'0"</b>	2880 mm <b>9'5"</b>	2865 mm <b>9'5"</b>	3480 mm <b>11'5"</b>
I Reach at max. height and 45° dump angle*	945 mm <b>3'1"</b>	865 mm <b>2'10"</b>	1040 mm <b>3'4"</b>	1090 mm <b>3'7"</b>	966 mm <b>3'2"</b>
J Reach at 2130 mm 7° clearance and 45° dump angle*	1590 mm <b>5'3"</b>	1545 mm <b>5'1"</b>	1635 mm <b>5'4"</b>	1635 mm <b>5'4"</b>	1975 mm <b>6'6"</b>
K Reach with arm horizontal and bucket level*	2370 mm <b>7'9"</b>	2255 mm <b>7'5"</b>	2505 mm <b>8'3"</b>	2450 mm <b>8'0"</b>	2655 mm <b>8'9"</b>
L Operating height (fully raised)	5285 mm <b>17'4"</b>	5150 mm <b>16'11"</b>	5435 mm <b>17'10"</b>	5360 mm <b>17'7"</b>	5700 mm <b>18'7"</b>
M Overall length (bucket on ground)	7360 mm <b>24'2"</b>	7310 mm <b>24'0"</b>	7475 mm <b>24'6"</b>	7465 mm <b>24'6"</b>	7750 mm <b>25'5"</b>
Loader clearance circle (bucket at carry, outside corner of bucket)	12050 mm <b>39'6"</b>	11990 mm <b>39'4"</b>	12130 mm <b>39'10"</b>	12220 mm <b>40'0"</b>	12370 mm <b>40'7"</b>
Digging depth: 0°	130 mm <b>5"</b>	130 mm <b>5"</b>	130 mm <b>5"</b>	110 mm <b>4.3"</b>	235 mm <b>9"</b>
10°	325 mm <b>1'1"</b>	310 mm <b>12"</b>	350 mm <b>1'2"</b>	320 mm <b>12.6"</b>	430 mm <b>1'5"</b>
Static tipping load: straight	10330 kg <b>22,774 lb</b>	10420 kg <b>22,972 lb</b>	10235 kg <b>22,564 lb</b>	9765 kg <b>21,528 lb</b>	9910 kg <b>21,848 lb</b>
40° full turn	8930 kg <b>19,687 lb</b>	9020 kg <b>19,886 lb</b>	8865 kg <b>19,544 lb</b>	8525 kg <b>18,794 lb</b>	8510 kg <b>18,761 lb</b>
Breakout force	131 kN 13375 kgf <b>29,487 lb</b>	147 kN 14965 kgf <b>32,992 lb</b>	116 kN 11805 kgf <b>26,026 lb</b>	111 kN 11370 kgf <b>25,067 lb</b>	154 kN 15700 kgf <b>34,621 lb</b>
Operating weight	12880 kg <b>28,396 lb</b>	12795 kg <b>28,208 lb</b>	12940 kg <b>28,528 lb</b>	13190 kg <b>29,079 lb</b>	12910 kg <b>28,462 lb</b>

\* At the end of tooth or B.O.C.E.

All dimensions, weights, and performance values based on ISO 7131, ISO 14397-1 and ISO 7546 standards. Static tipping load and operating weight shown include lubricant, coolant, full fuel tank, ROPS cab and operator. Machine stability and operating weight affected by tire size and attachments.

## FORK

	Fork With Quick Coupler
O Fork tine length	1220 mm <b>4'0"</b>
P Ground to top of tine at maximum lift	3825 mm <b>12'7"</b>
Q Reach at maximum lift	810 mm <b>2'8"</b>
R Ground to top of tine - boom and tine level	1840 mm <b>6'0"</b>
S Reach - boom and tine level	1715 mm <b>5'6"</b>
T Reach - tine level on ground	1055 mm <b>3'6"</b>
U Overall length - tine level on ground	7860 mm <b>25'9"</b>
Static tipping load - boom level: straight	7320 kg
fork level, tine center	<b>16,138 lb</b>
40° full turn	6405 kg
Operating weight	12905 kg <b>28,451 lb</b>

Operating load per SAE J1197 (Oct, 2011), 50% of static tipping load.

Static tipping load and operating weight shown include lubricant, coolant, full fuel tank, ROPS cab and operator. Machine stability and operating weight affected by tire size and attachments.



## WEIGHT CHANGES

Tires or attachments	Change in operating weight		Change in tipping load				Width over tires		Ground clearance		Change in vertical dimensions	
	kg	lb	Straight		Full turn		mm	ft in	mm	ft in	mm	ft in
			kg	lb	kg	lb						
20.5-25-12PR (L2)	-165	-364	-115	-254	-100	-220	2470	8' 1"	465	1' 6"	0	0
Remove additional counterweight	-280	-617	-515	-1135	-440	-970	0	0	0	0	0	0



## STANDARD EQUIPMENT

- 2-spool valve for boom and bucket control
- Alternator, 24 V/ 90 A
- Automatic hydraulic-driven fan with automatic reverse rotation
- Back-up alarm
- Batteries, 92 Ah/12V (2), 680 CCA
- Battery disconnect
- Boom kick-out, in-cab adjustable
- Bucket positioner
- Color, rear-view camera and monitor
- Counterweight, standard and additional
- Electronically Controlled Suspension System
- Engine, Komatsu SAA6D107E-3 diesel
- Engine shut-off system, electric
- Equipment Management Monitoring System (EMMS)
  - Lights (central warning, brake oil pressure, engine oil pressure, parking brake, cooling fan reverse, KDPF restriction, seat belt caution, Komtrax message)
  - Gauges (DEF level, Engine water temperature, ecology, Fuel level, HST oil temperature, speedometer/tachometer), variable speed display
- Front fenders
- Fuel pre-filter with water separator
- Horn, electric
- Hydrostatic transmission
- Komatsu SmartLoader Logic
- Komatsu Auto Idle Shutdown
- KOMTRAX® Level 5
- Lift cylinders and bucket cylinder
- Lights
  - Back-up light
  - Stop and tail light
  - Turn signal lamps, 2 front and 2 rear with hazard switch
  - Working lights, halogen, 2 front cab mount
  - Working lights, halogen, 2 front fender mount
  - Working lights, halogen, 2 rear grill mount
- Loader linkage with standard lift arm
- Multifunction mono-lever loader control with transmission F/R switch
- Parking brake, electric
- Radiator, wider core
- Radiator mask, swing up
- Rear view mirrors, outside (2) inside (2)
- Rims for 20.5-R25 tires
- ROPS/FOPS Cab Level 2
  - 2 x DC12V electrical outlets
  - Ashtray
  - Auto air conditioner
  - Cigarette lighter, 24V
  - Color LCD/TFT multi-monitor
  - Cup holder
  - Floor mat
  - Operator seat, reclining, air suspension type, heated
  - Radio, AM/FM with AUX input jack
  - Rear defroster, electric
  - Seatbelt, 2-point retractable, 76mm 3" width
  - Space for lunch box
  - Steering wheel, tilt and telescopic
  - Sun visor, front window
  - Windshield washer and wiper, front with intermittent
  - Windshield washer and wiper, rear
- Service brakes, wet disc type
- Starting motor, 5.5 kW
- Transmission speed ranges, 4 forward and 4 reverse
- Vandalism protection kit, padlocks for battery box (2)



## OPTIONAL EQUIPMENT

- Auxiliary steering (SAE)
- Centrifugal engine air pre-cleaner
- Cutting edge (bolt-on type)
- Engine oil and coolant heater
- Guarding package
- High lift boom and bucket cylinder
- Limited slip differential (F&R)
- Lube system
- Quick coupler
- Rear full fenders
- Three-spool valve (will utilize integrated proportional control switch included in the multi-function mono-lever) and piping
- Various tire options, radial and bias
- Various bucket and fork options

AESS902-04

©2019 Komatsu America Corp.

Printed in USA

AD02(1.5M)OTP

02/19 (EV1)

# KOMATSU®

*Note: All comparisons and claims of improved performance made herein are made with respect to the prior Komatsu model unless otherwise specifically stated.*

www.komatsuamerica.com

Komatsu America Corp. is an authorized licensee of Komatsu Ltd. Materials and specifications are subject to change without notice

KOMATSU®, Komatsu Care®, KOMTRAX® and KOMTRAX Plus® are registered trademarks of Komatsu Ltd. All other trademarks and service marks used herein are the property of Komatsu Ltd., Komatsu America Corp. or their respective owners or licensees.

WA270-8